

FICHE TECHNIQUE

Aménagement hydraulique – Canal de régulation d'eau

Flexi-Collecteur



Contrôle :

- du drainage
- de l'érosion
- des eaux pluviales
- de l'irrigation
- des déversements

Flexi-Collecteur

1. Principe

Flexi-Collecteur est un système de **revêtement étanche de canal** permettant de réguler et de diriger l'écoulement de l'eau ou des liquides critiques. Fabriqué à partir de polyéthylène HDPE résistant aux UV et éprouvé, le système Flexi-Collecteur, grâce à sa conception ondulée, permet de **réguler le débit d'eau** sur les terrains en pente.

2. Performances de débit

Pente %	12" TRAPEZOIDAL*		24" TRAPEZOIDAL*		24" SEMI CIRCULAIRE		MegaDitch (1 fond ; 1 paroi latérale @ pente latérale 1:1 ; profondeur d'écoulement de 0.69m)	
	Débit cms	Vitesse mps	Débit cms	Vitesse mps	Débit cms	Vitesse mps	Débit cms	Vitesse mps
0.50	0.1747	0.9418	0.7940	1.3777	0.1532	0.9449	3.2448	1.9080
1.00	0.2469	1.3350	0.8637	1.4966	0.2169	1.3350	3.5297	2.0757
2.50	0.3004	1.6215	1.3657	2.3683	0.2636	1.6246	5.5801	3.2796
5.00	0.4248	2.2951	1.9312	3.3498	0.3729	2.2951	7.8928	4.6391
7.50	0.5202	2.8103	2.4219	4.1026	0.4568	2.8133	9.6668	5.6815
10.00	0.6006	3.2461	2.7314	4.7366	0.5273	3.2492	11.1622	6.5623
15.00	0.7357	3.9746	3.3451	5.8003	0.6459	3.9776	13.6708	8.0376
20.00	0.8495	4.5903	3.8627	6.6995	0.7459	4.5933	15.7858	9.2812

3. Couleurs

Flexi-Collecteur est disponible en 3 coloris :



Noir

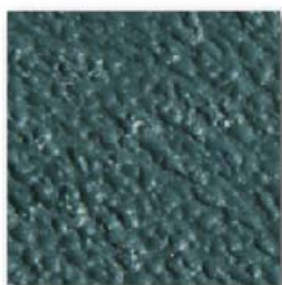

Vert



Beige

Flexi-Collecteur

4. Dimensions

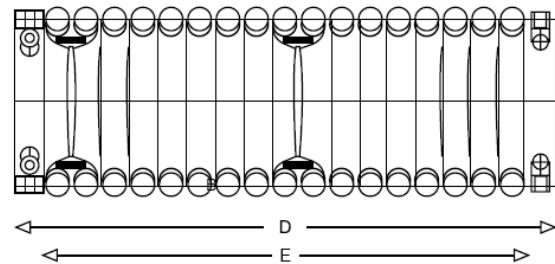
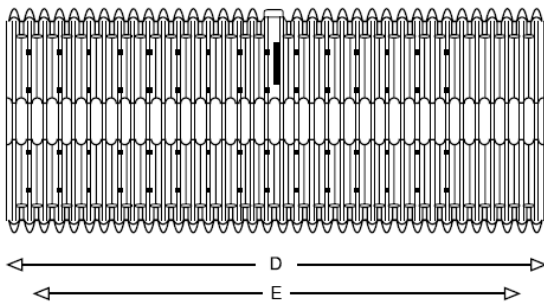
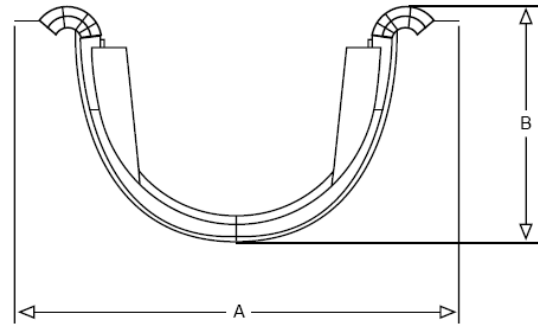
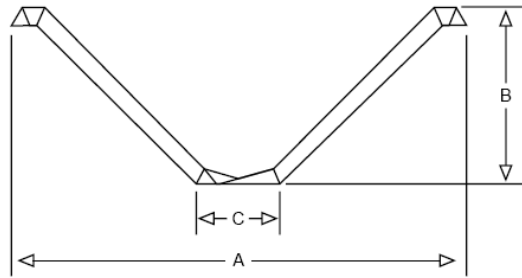





Description	#	12" trapézoïdale	24" trapézoïdale	24" semi-circulaire
Largeur extérieure globale	A	1270.00 mm	2032.00 mm	990.60 mm
Hauteur extérieure globale	B	412.75 mm	762.00 mm	482.60 mm
Canal inférieur largeur extérieur	C	254.00 mm	387.00 mm	N/A
Longueur extérieure globale	D	3048.00 mm	2463.00 mm	2362.20 mm
Longueur utile	E	2844.80 mm	2356.00 mm	2235.20 mm
Poids par pièce	N/A	21.77 kg	35.83 kg	19.05 kg

Flexi-Collecteur

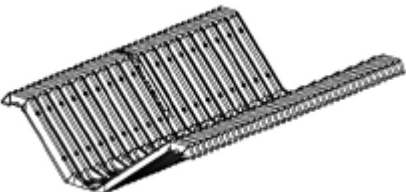
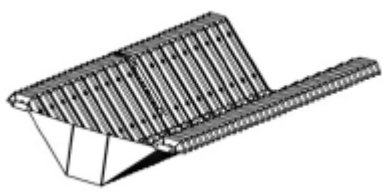
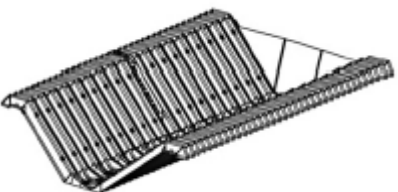
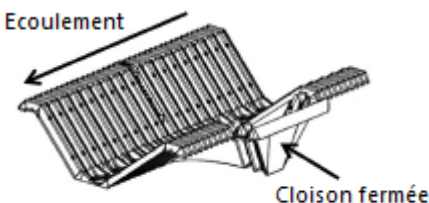
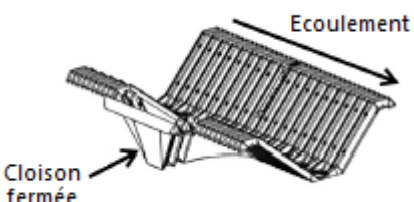
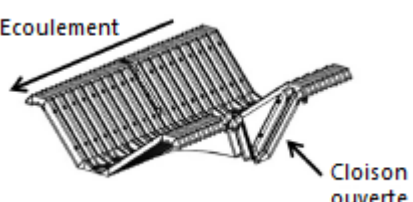
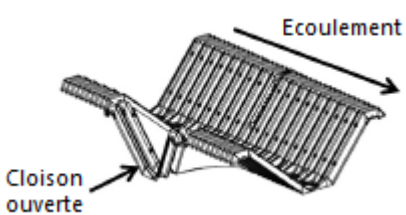





5. Détails pièces

12" Trapézoïdal

<p><u>Section droite</u> Ref : T12SBX</p> 	<p><u>Cloison aval</u> Ref : T12EBAX</p> 
<p><u>Cloison amont</u> Ref : T12EUBX</p> 	<p><u>Porte gauche</u> Ref : T12GBX</p> 
<p><u>Porte droite</u> Ref : T12GRBX</p> 	<p><u>T gauche</u> Ref : T12TBAX</p> 
<p><u>T droite</u> Ref : T12TRBX</p> 	<p><u>Section de fin</u> Ref : T12IOBX</p> 
<p><u>Triple cloison</u> Ref : --</p> 	<p><u>Section de transition 12 à 24</u> Ref : T2412UAX (amont) / T2412DAX (aval)</p> 

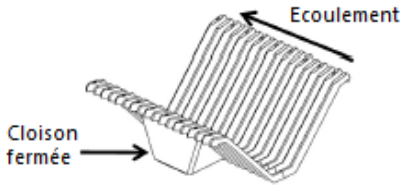
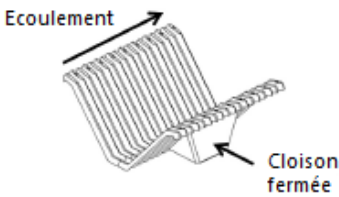
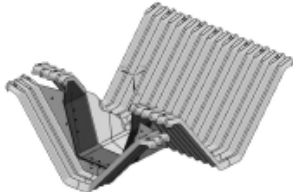
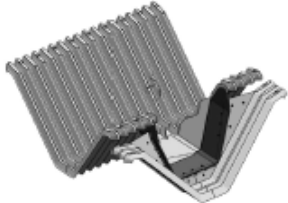
Flexi-Collecteur

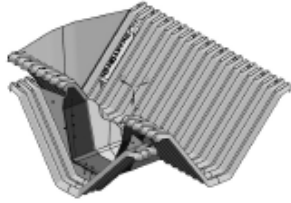
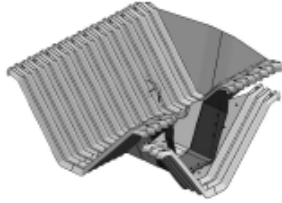
24" Trapézoïdal

<p>Section droite Ref : TRAP</p> 	<p>Cloison aval Ref : T24BDSX</p> 
<p>Cloison amont Ref : T24BUSX</p> 	<p>Porte gauche Ref : TRAPGLX</p> 
<p>Porte droite Ref : TRAPGRX</p> 	<p>T gauche Ref : T24TLBAX</p> 
<p>T droit Ref : T24TRBAX</p> 	<p>Section de fin Ref : TRAPIOBX</p> 
<p>Coin gauche Ref : T24CLBAX</p> 	<p>Coin droit Ref : T24CRBAX</p> 
<p>Section de transition Ref : T2412UAX (amont) / T2412DAX (aval)</p> 	<p>Triple cloison Ref : --</p> 